



Grupo Librado



www.grupolibrado.es

ABOVE GROUND POOLS



SEAL&LOCK SYSTEM™



FRAMELINK SYSTEM™



NO TOOLS REQUIRED
Aucun outil nécessaire
No necesita herramientas
kein Werkzeug notwendig
Geen gereedschap nodig
Attrezzi non necessari
Bez użycia narzędzi



SETUP TIME
Temps de montage
Tiempo de montaje
Montagezeit
Montagetijd
Tempo di montaggio
Czas montażu

ITEM · Article · Artículo · Artikel · Artikel · Prodotto · Artykul

- # 56418
- ← 366 x 100cm
12' x 39.5"
- (TM) STEEL PRO MAX™
- 37.72kg
83,16lb

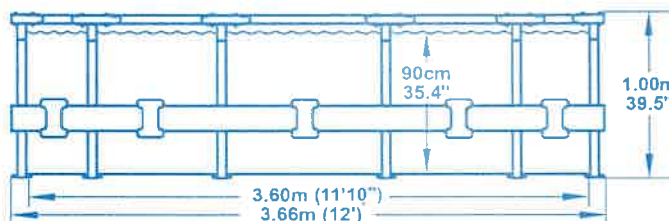

90%



FEATURES · Caractéristiques · Características · Eigenschaften · Kenmerken · Caratteristiche · Cechy



PVC/TRITECH™



INNER MOSAIC PRINT
Motif intérieur mosaïque
Estampado interno de mosaico
Innenverkleidung: mosaikoptik
Mozaiek Print
Stampa interna mosaico
Nadruk wewnętrzny mozaika



Ø 32mm
Ø 1.25"

INCLUDES · Inclus · Incluye · Inhalt · Bevat · Include · Zawiera



58094

CARTRIDGE
Cartouche
Cartucho
Kartusche
Filter
Cartuccia
Wkład



58330

LADDER
Échelle
Escalera
Sicherheitsleiter
Ladder
Scaleta
Drabinka

FILTRATION SYSTEM · Système de filtrage · Sistema de filtración · Filtersystem · Filtersysteem · Sistema di filtraggio · system filtrujący



FILTER PUMP 58383 2.006 L/h - 530 gal/h
Pompe de filtration 58383 2.006 L/h
Bomba de filtrado 58383 2.006 L/h
Filterpumpe 58383 2.006 L/h
Filterpomp 58383 2.006 L/h
Filtro a cartuccia 58383 2.006 L/h
System filtrujący 58383 2.006 L/h



220-240V
50HZ

VOLTAGE
Tension
Tensión
Spannung
Voltage
Tensione
Napięcie

CD. 06000668

329⁹⁰ €

IVA INCLUIDO

Bestway

www.bestwaycorp.com



Grupo Librado



www.grupollibrado.es

ABOVE GROUND POOLS



SEAL&LOCK SYSTEM™



FRAMELINK SYSTEM™



NO TOOLS REQUIRED
Aucun outil nécessaire
No necesita herramientas
kein Werkzeug notwendig
Geen gereedschap nodig
Attrezzi non necessari
Bez użycia narzędzi



SETUP TIME
Temps de montage
Tiempo de montaje
Montagezeit
Montagetijd
Tempo di montaggio
Czas montażu

ITEM · Article · Artículo · Artikel · Artikel · Prodotto · Artykul

- # 56420
- ↔ 366 X 122cm
12' X 48"
- ™ STEEL PRO MAX™
- 📦 48,58kg
107,10lb

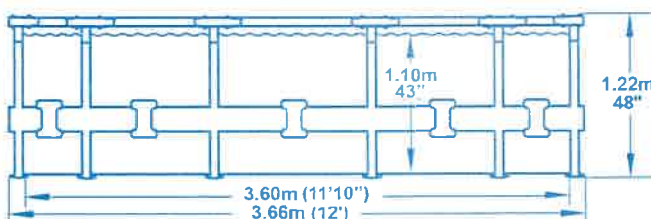

90%



FEATURES · Caractéristiques · Características · Eigenschaften · Kenmerken · Caratteristiche · Cechy



PVC/TRITECH™



INNER MOSAIC PRINT
Motif intérieur mosaïque
Estampado interno de mosaico
Innenverkleidung: mosaikoptik
Mozaiek Print
Stampa interna mosaico
Nadruk wewnętrzny mozaika



Ø 32mm
Ø 1.25"

INCLUDES · Inclus · Incluye · Inhalt · Bevat · Include · Zawiera



58094

CARTRIDGE
Cartouche
Cartucho
Kartusche
Filter
Cartuccia
Wkład



58037

COVER
Bâche
Cubierta
Abdeckhaube
Afdekhoes
Copertura
Pekryw



58331

LADDER
Échelle
Escalera
Sicherheitsleiter
Ladder
Scaletta
Drabinka

FILTRATION SYSTEM · Système de filtrage · Sistema de filtración · Filtersystem · Filtersystem · Sistema di filtraggio · system filtrujący



FILTER PUMP 58383 2.006 L/h - 530 gal/h
Pompe de filtration 58383 2.006 L/h
Bomba de filtrado 58383 2.006 L/h
Filterpumpe 58383 2.006 L/h
Filterpomp 58383 2.006 L/h
Filtro a cartuccia 58383 2.006 L/h
System filtruj cy 58383 2.006 L/h



220-240V
50HZ

VOLTAGE
Tension
tensión
Spannung
Voltage
Tensione
Napięcie

CD. 06000669

389⁹⁰ €

IVA INCLUIDO

Bestway

www.bestwaycorp.com



Grupo Librado



www.grupolibrado.es

ABOVE GROUND POOLS



FRAMELINK SYSTEM™



NO TOOLS REQUIRED
Aucun outil nécessaire
No necesita herramientas
Kein Werkzeug notwendig
Geen gereedschap nodig
Attrezzi non necessari
Bez użycia narzędzi



SETUP TIME
Temps de montage
Tiempo de montaje
Montagezeit
Montagetijd
Tempo di montaggio
Czas montażu



ITEM · Article · Artículo · Artikel · Artikel · Prodotto · Artykuł

- # 56411
- ← 300 x 201 x 66cm
9'10" x 6'7" x 26"
- TM STEEL PRO™
- 20,12kg
44,36lb

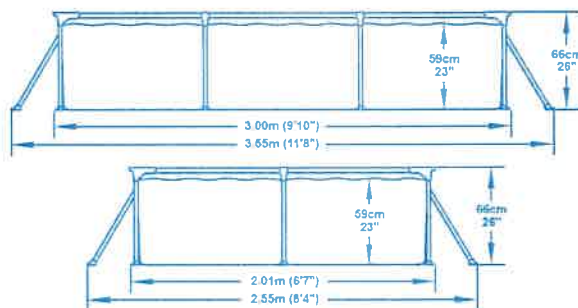

90%



3,300L
872gal.

FEATURES · Caractéristiques · Características · Eigenschaften · Kenmerken · Caratteristiche · Cechy



DURAPLUS™



Ø 32mm
Ø 1.25"

INCLUDES · Inclus · Incluye · Inhalt · Bevat · Include · Zawiera



58381

FILTER PUMP
Pompe de filtration
Bomba de filtrado
Filterpumpe
Filterpomp
Filtro a cartuccia
System filtruj cy



58093

CARTRIDGE
Cartouche
Cartucho
Kartusche
Filter
Cartuccia
Wkład

FILTRATION SYSTEM · Système de filtration · Sistema de filtración · Filtersystem · Filtersystem · Sistema di filtraggio · System filtrujący



58381

FILTER PUMP 1.249 L/h - 330 gal/h
Pompe de filtration 1.249 L/h
Bomba de filtrado 1.249 L/h
Filterpumpe 1.249 L/h
Filterpomp 1.249 L/h
Filtro a cartuccia 1.249 L/h
System filtruj cy 1.249 L/h



220-240V
50HZ

VOLTAGE
Tension
Tensión
Spannung
Voltage
Tensione
Napięcie

CD. 06000670

159⁹⁰
€

IVA INCLUIDO

Bestway

www.bestwaycorp.com



Grupo Librado



www.grupolibrado.es

ABOVE GROUND POOLS



SEAL & LOCK SYSTEM™



NO TOOLS REQUIRED
Aucun outil nécessaire
No necesita herramientas
Kein Werkzeug notwendig
Geen gereedschap nodig
Attrezzi non necessari
Bez użycia narzędzi



SETUP TIME
Temps de montage
Tiempo de montaje
Montagezeit
Montage tijd
Tempo di montaggio
Czas montażu

ITEM · Article · Artículo · Artikel · Artikel · Prodotto · Artykuł

56456

← 412 X 201 X 122cm
13'6" X 6'7" X 48"

TM POWER STEEL™

72.45kg
159.72lb

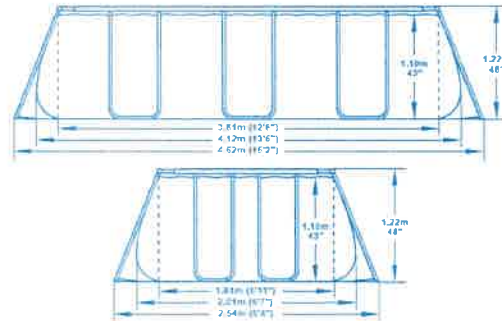

90%



FEATURES · Caractéristiques · Características · Eigenschaften · Kenmerken · Caratteristiche · Cechy



PVC/TRITECH™



INNER MOSAIC PRINT
Motif intérieur mosaïque
Estampado interno de mosaico
Innenverkleidung: mosaikoptik
Mozaiek Print
Stampa interna mosaico
Nadruk wewnętrzny mozaika



Ø 32mm
Ø 1.25"

INCLUDES · Inclus · Incluye · Inhalt · Bevat · Include · Zawiera



58383

FILTER PUMP
Pompe de filtration
Bomba de filtrado
Filterpumpe
Filterpomp
Filtro a cartuccia
System filtruj cy



58094

CARTRIDGE
Cartouche
Cartucho
Kartusche
Filter
Cartuccia
Wkład



58331

LADDER
Echelle
Escalera
Sicherheitsleiter
Ladder
Scaletta
Drabinka



58501

CHEMCONNECT™ DISPENSER
Diffuseur ChemConnect™
Dispensador ChemConnect™
ChemConnect™ Chemikaliendosierer
ChemConnect™ dispenser
Galleggiante chimico ChemConnect™
Dozownik ChemConnect™

FILTRATION SYSTEM · Système de filtrage · Sistema de filtración · Filtersystem · Filtersystem · Sistema di filtraggio · System filtrujący



58383

FILTER PUMP 2.006 L/h - 530 gal/h
Pompe de filtration 2.006 L/h
Bomba de filtrado 2.006 L/h
Filterpumpe 2.006 L/h
Filterpomp 2.006 L/h
Filtro a cartuccia 2.006 L/h
System filtruj cy 2.006 L/h



220-240V
50HZ

VOLTAGE
Tension
Tensión
Spannung
Voltage
Tensione
Napięcie

CD. 06000671

525⁰⁰ €

IVA INCLUIDO

Bestway

www.bestwaycorp.com



Grupo Librado



www.grupolibrado.es

ABOVE GROUND POOLS



SEAL & LOCK SYSTEM™



NO TOOLS REQUIRED
Aucun outil nécessaire
No necesita herramientas
Kein Werkzeug notwendig
Geen gereedschap nodig
Attrezzi non necessari
Bez. użycia narzędzi



SETUP TIME
Temps de montage
Tiempo de montaje
Montagezeit
Montagetijd
Tempo di montaggio
Czas montażu



ITEM · Article · Artículo · Artikel · Artikel · Prodotto · Artykul

56670

← 488 x 244 x 122cm
16' x 8' x 48"

TM POWER STEEL™

94,22kg
207,72lb

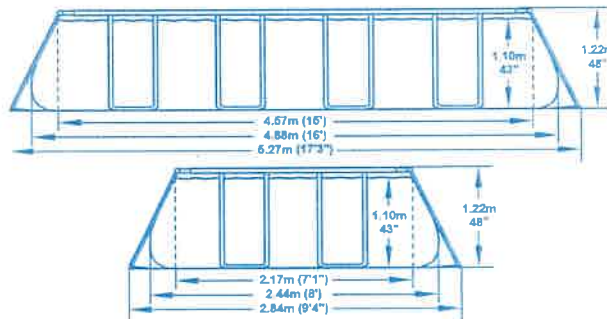

90%



FEATURES · Caractéristiques · Características · Eigenschaften · Kenmerken · Caratteristiche · Cechy



PVC/TRITECH™



INNER MOSAIC PRINT
Motif intérieur mosaïque
Estampado interno de mosaico
Innenverkleidung: mosaikoptik
Mozaiek Print
Stampa interna mosaico
Nadruk wewnętrzny mozaika



Ø 32mm
Ø 1.25"

INCLUDES · Inclus · Incluye · Inhalt · Bevat · Include · Zawiera



58386

FILTER PUMP
Pompe de filtration
Bomba de filtrado
Filterpumpe
Filterpomp
Filtro a cartuccia
System filtruj cy



58094

CARTRIDGE
Cartouche
Cartucho
Kartusche
Filter
Cartuccia
Wkład



58472

COVER
Bâche
Cubierta
Abdeckhaube
Afdekhoes
Copertura
Pokrywa



58331

LADDER
Échelle
Escalera
Sicherheitsleiter
Ladder
Scaletta
Drabinka



58501

CHEMCONNECT™ DISPENSER
Diffuseur ChemConnect™
Dispensador ChemConnect™
ChemConnect™ Chemikaliendosierer
ChemConnect™ dispenser
Galleggiate chimico ChemConnect™
Dozownik ChemConnect™

FILTRATION SYSTEM · Système de filtration · Sistema de filtración · Filtersystem · Filtersystem · Sistema di filtraggio · System filtrujący



58386

FILTER PUMP 3.028 L/h - 800 gal/h
Pompe de filtration 3.028 L/h
Bomba de filtrado 3.028 L/h
Filterpumpe 3.028 L/h
Filterpomp 3.028 L/h
Filtro a cartuccia 3.028 L/h
System filtruj cy 3.028 L/h



220-240V
50HZ

VOLTAGE
Tension
Tensión
Spannung
Voltage
Tensione
Napięcie

CD. 06000672

850⁰⁰
€

IVA INCLUIDO

Bestway

www.bestwaycorp.com



Grupo Librado



www.grupolibrado.es

ABOVE GROUND POOLS



NO TOOLS REQUIRED
Aucun outil nécessaire
No necesita herramientas
kein Werkzeug notwendig
Geen gereedschap nodig
Attrezzi non necessari
Bez użycia narzędzi



SETUP TIME
Temps de montage
Tiempo de montaje
Montagezeit
Montagetijd
Tempo di montaggio
Czas montażu

ITEM · Article · Artículo · Artikel · Artikel · Prodotto · Artykul

57270

305 x 76cm
10' x 30"

FAST SET™

10kg
22.05lb

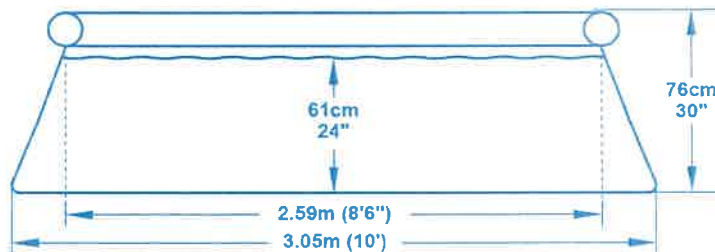

80%



FEATURES · Caractéristiques · Características · Eigenschaften · Kenmerken · Caratteristiche · Cechy



PVC/TRITECH™



INFLATABLE TOP RING

Anneau gonflable
Aro inflable
Aufblasbarer Luftring
Opblaasrand
Anello gonfiabile
Nadmuchiwany górny pierścień



Ø 32mm
Ø 1.25"

INCLUDES · Inclus · Incluye · Inhalt · Bevat · Include · Zawiera



FILTER PUMP
Pompe de filtration
Bomba de filtrado
Filterpumpe
Filterpomp
Filtro a cartuccia
System filtruj cy

58381



CARTRIDGE

Cartouche
Cartucho
Kartusche
Filter
Cartuccia
Wkład

58093

FILTRATION SYSTEM · Système de filtrage · Sistema de filtración · Filtersystem · Filtersystem · Sistema di filtraggio · System filtrujący



FILTER PUMP 1.249 L/h - 330 gal/h
Pompe de filtration 1.249 L/h
Bomba de filtrado 1.249 L/h
Filterpumpe 1.249 L/h
Filterpomp 1.249 L/h
Filtro a cartuccia 1.249 L/h
System filtruj cy 1.249 L/h

58381



VOLTAGE

Tension
Tensión
Spannung
Voltage
Tensione
Napięcie

220-240V
50HZ

CD. 06000673

79'90
€

IVA INCLUIDO

Bestway

www.bestwaycorp.com



Grupo Librado



www.grupolibrado.es

ABOVE GROUND POOLS



NO TOOLS REQUIRED
Aucun outil nécessaire
No necesita herramientas
kein Werkzeug notwendig
Geen gereedschap nodig
Attrezzi non necessari
Bez uzycia narzedzi



SETUP TIME
Temps de montage
Tiempo de montaje
Montagezeit
Montagetijd
Tempo di montaggio
Czas montażu

ITEM · Article · Artículo · Artikel · Artikel · Prodotto · Artykuł

- # 57274
- ← 366 x 76cm
12' x 30"
- (TM) FAST SET™
- 14kg
30.8lb

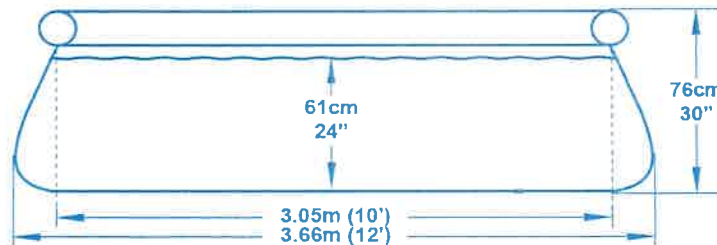

80%



FEATURES · Características · Características · Eigenschaften · Kenmerken · Caratteristiche · Cechy



PVC/TRITECH™



INFLATABLE TOP RING

Anneau gonflable
Aro inflable
Aufblasbarer Lufring
Opblaasrand
Anello gonfiabile
Nadmuchiwany górny pierścień



Ø 32mm
Ø 1.25"

INCLUDES · Inclus · Incluye · Inhalt · Bevat · Include · Zawiera



FILTER PUMP
Pompe de filtration
Bomba de filtrado
Filterpumpe
Filterpomp
Filtro a cartuccia
System filtruj cy

58381



CARTRIDGE
Cartouche
Cartucho
Kartusche
Filter
Cartuccia
Wkład

58093

FILTRATION SYSTEM · Système de filtrage · Sistema de filtración · Filtersystem · Filtersysteem · Sistema di filtraggio · System filtrujący



FILTER PUMP 1.249 L/h - 330 gal/h
Pompe de filtration 1.249 L/h
Bomba de filtrado 1.249 L/h
Filterpumpe 1.249 L/h
Filterpomp 1.249 L/h
Filtro a cartuccia 1.249 L/h
System filtruj cy 1.249 L/h

58381



220-240V
50HZ

VOLTAGE
Tension
Tensión
Spannung
Voltage
Tensione
Napięcie

CD. 06000674

95'00 €

IVA INCLUIDO

Bestway

www.bestwaycorp.com